

Article number: 03506100

Description: Fluro Rod end GE 100FO-2RS

Measures

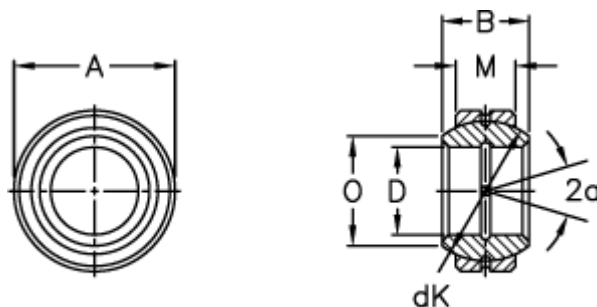

Str. 6-12 uden smørerille

A	= 160 0 -0,025	Tilt angle = 14
B	= 85	Weight = 5900
D	= 100 0 -0,020	
dK	= 140	
Dynamic load C (kN)	= 655	
M	= 55	
O	= 111.2	
Static load C0 (kN)	= 3250	